

## Galvanised Cone Fan 54' 02382835

### Technical data

Voltage	U	230/400	V
Phase		3	~
Frequency		60	Hz
Speed		595	RPM
Power consumption	Pe	1500	W
Nominal current	I	4.8/2.8	A
Maximum current	I	5.5/3.2	A
Capacitor	I	-	µF
Ambient temperature	Tamb min/max	-25...40	°C
Insulation Class		CLF	
IP Class Fan		IP55	
Sound pressure level at 2 m	Lp	77	dB(A)
Weight		83.6	kg

### Fan details

Impeller blades	3
Impeller type	12
Impeller system	B
Impeller material	PG

### Control options

Triac controller	No
Transformer	No
Frequency drive	No
Intelligent Fan Drive	No

### Dimensions

A01	1375 mm
A08	135 mm
A09	295 mm
A19	1480 mm
A20	1480 mm
A22	1356 mm
A26	1657 mm
A31	85 mm

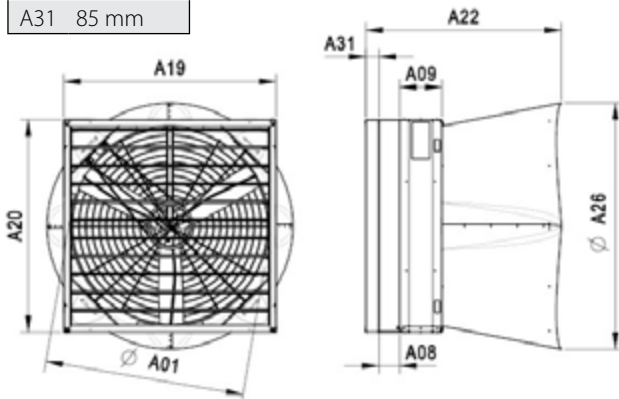

## Exhaust Fans

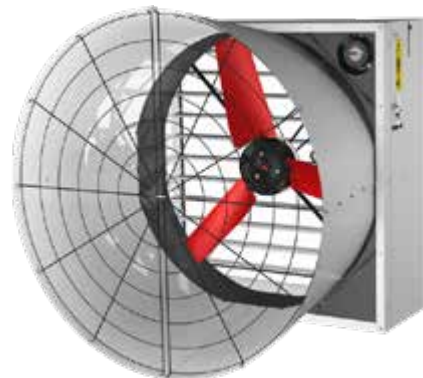

### Approval(s)



No.17432

### Wiring diagram - Fan

AB02 - CW

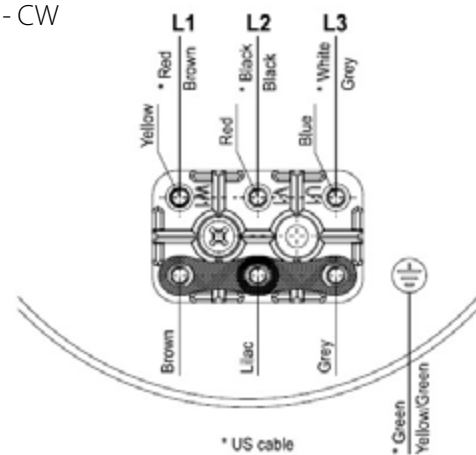

### Characteristics

0 Pa 52800 m<sup>3</sup>/h  
50 Pa 42300 m<sup>3</sup>/h

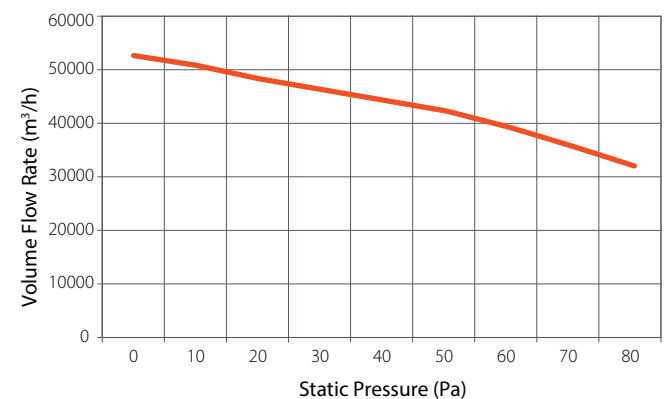

Feeding



Drinking



Climate



Housing

Maagan Michael, D.N. Menashe, 3780500, Israel

Tel: +972-73-2413001, Fax: +972-73-2333711

info@plassonlivestock.com | www.plassonlivestock.com