

Galvanised Cone Fan w/ Butterfly 54" 02382837

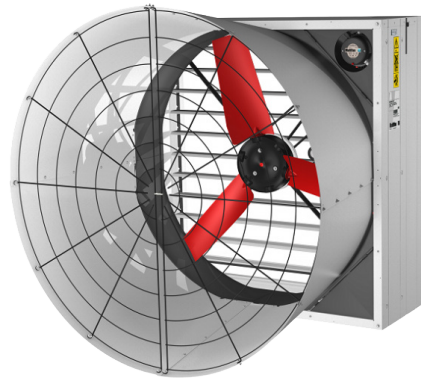

Technical data

Voltage	U	230/400	V
Phase		3	~
Frequency		60	Hz
Speed		510	RPM
Power consumption	Pe	800	W
Nominal current	I	3.3/1.9	A
Maximum current	I	3.7/2.1	A
Capacitor	I	-	µF
Ambient temperature	Tamb min/max	-25...40	°C
Insulation Class		CLF	
IP Class Fan		IP55	
Weight		89.7	kg

Fan details

Impeller blades	3
Impeller type	12
Impeller system	B
Impeller material	PG

Control options

Triac controller	No
Transformer	No
Frequency drive	No
Intelligent Fan Drive	No

Dimensions

A01	1375 mm
A09	295 mm
A19	1480 mm
A20	1480 mm
A22	1232 mm
A26	1657 mm
A31	96 mm

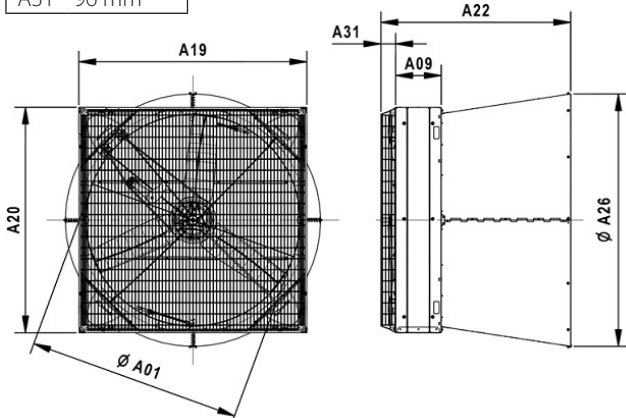

Approval(s)



No.17417

Wiring diagram - Fan

AB01 - CCW

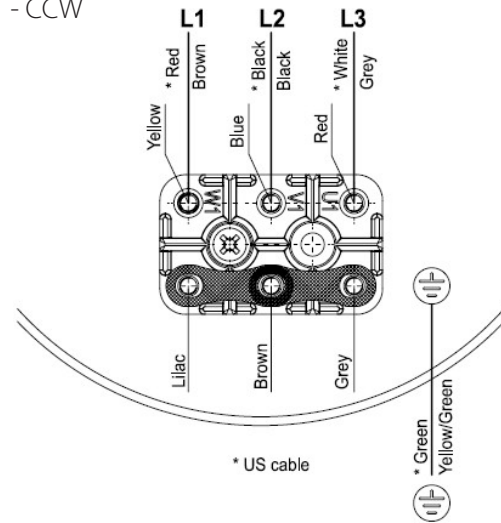

Characteristics

0 Pa 42300 m³/h
50 Pa 28100 m³/h

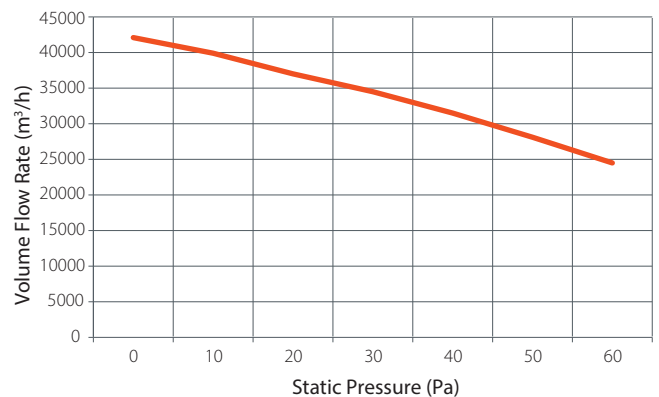

Feeding



Drinking



Climate



Housing

Maagan Michael, D.N. Menashe, 3780500, Israel

Tel: +972-73-2413001, Fax: +972-73-2333711

info@plassonlivestock.com | www.plassonlivestock.com